

Sedna

VA4220WF

VA4221WF

Installation Guide

Smart Water Valve

The installation of this valve should be performed by a certified professional in conformity with local and national construction codes. The valve closes with sufficient force to cut a finger. ALWAYS keep your fingers away from the ball valve.

Although each unit is pre-tested at the factory, it is strongly recommended that you test the valve before installation to ensure proper operation in your home.

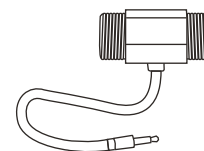

Flow Sensor
FS4220

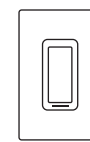

Light switch / Dimmers
SW2500ZB
DM2500ZB / DM2550ZB

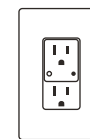

Smart Outlet
SP2610ZB



Smart Plug
SP2600ZB

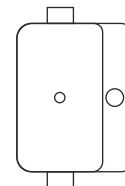

Load Controller
RM3250ZB

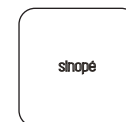

Multicontroller
MC3100ZB



STEP 1 CONNECTING THE VALVE TO YOUR WI-FI NETWORK

1



Download the free Neviweb app on your device from the AppStore or Google Play*.



*It is also possible to operate the valve without an Internet connection. However, you will not be notified when a water leak is detected. Refer to the "Support" section of our Website at www.sinopetech.com.

2

Remove the valve cover by unscrewing the 4 screws with a flat screwdriver.

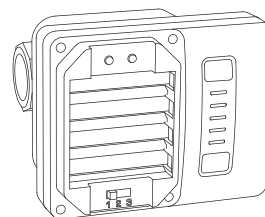

3

Connect the valve to an electrical outlet, using the supplied adapter, near where it will be installed. By doing so, you will validate the range of the Wi-Fi communication between the valve and your network.

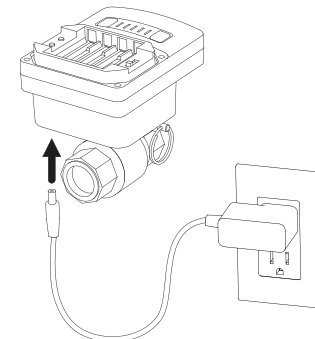

4

Open the app and log into your Neviweb account or create an account.

Follow the steps to add a device.

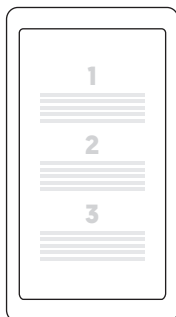

5

Connect your Sinopé smart water leak detectors (Step 2).

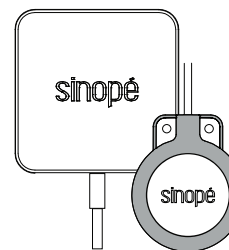

STEP 2 CONNECTING THE WATER LEAK DETECTORS TO THE SMART WATER VALVE

1

The mode switch of the valve must be in position "1".

The valve must be plugged into a power outlet.

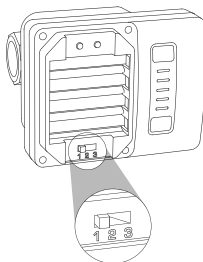

2

Press the "B" button to open the network connectivity session for the detectors.

The indicator lights will light up in sequence to indicate that the session is active.

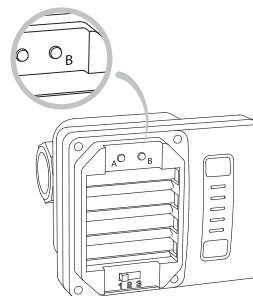

3

Connect the detector to the network from its installation location. This will ensure it is within range of the RF signal of the valve.

Remove the cover and pull out the battery tab to activate the device.

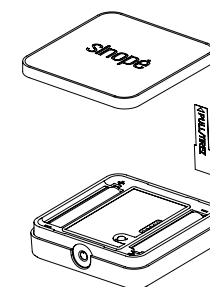

4

Press the detector's connection button.

Light	Status
Green light blinks	Device is connecting
Green light lit for 10 s	Successful connection
Red light turns on	Connection has failed*

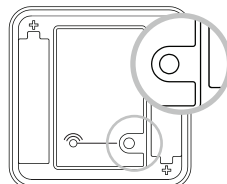

5

Once all the detectors are connected, press the "B" button on the valve to close the connectivity session.

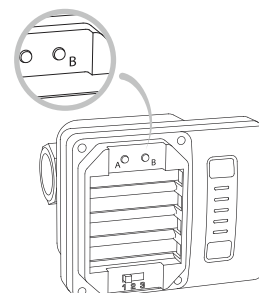

The connection can be verified at any time by pressing the water leak detector's button. The indicator light will light up in green for 10 seconds if the unit is connected.

*Refer to the "Support" section of our Website at www.sinopetech.com.

STEP 3 INSTALLATION OF THE SMART WATER LEAK DETECTORS

Place detectors (WL4200) where potential water leakage may occur:

- Water heater
- Drain pump
- Bathtub
- Sink
- Etc.

Water leak detectors with sensor (WL4200S) are designed to be used in hard-to-reach places :

- Below dishwasher
- Behind washing machine
- Etc.

1

Connect the sensor to the detector.

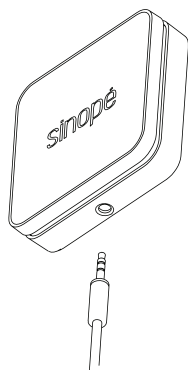

2

Attach the detector to a clean surface where there is no risk of immersion. Use the provided screws or the non-permanent adhesive located on the back of the product.

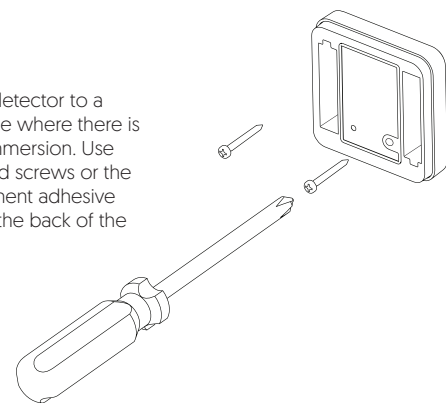

3

Put down the sensor or attach it to the wall. The electrodes must face the ground.

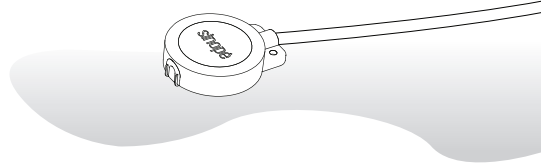

4

Test the detector by putting the electrodes in contact with a small amount of water (1 tsp). The audible alarm will be activated. Wipe the electrodes with a dry cloth to cease the alarm.

If the alarm isn't activated, refer to our Website.

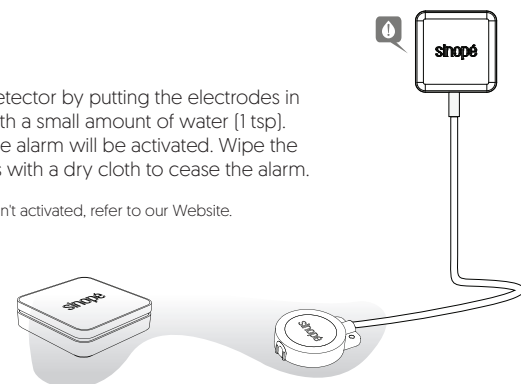

STEP 4 INSTALLATION OF THE SMART WATER VALVE

1

Make sure the valve is in the "OPEN" position before proceeding with the installation. Separate the controller from the ball valve: **A)** Remove the pin **B)** Tilt the controller back and slide it backwards

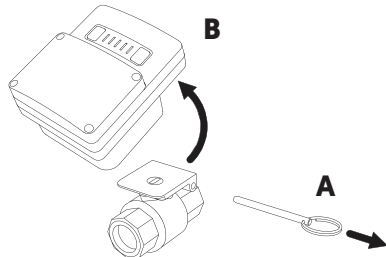

2

Close the main water supply. Open the hot and cold faucets near the main water supply to reduce the water pressure.

Remove the valve safety caps.

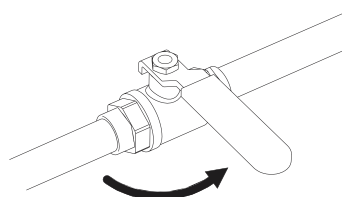

3

Install the smart water valve just downstream of the main water shut-off valve. Depending on your plumbing, additional fittings may be required (not included).

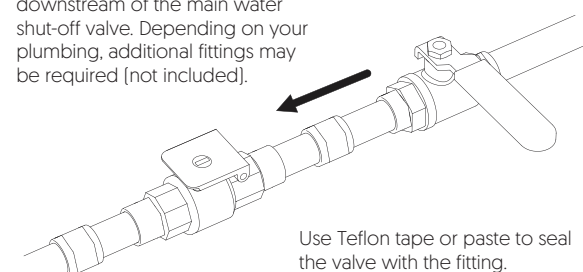

4

Before replacing the controller, make sure that both the valve and controller are in the "OPEN" position.

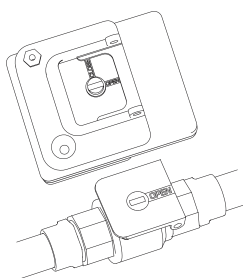

5

Put the controller back in place and insert the pin to secure the controller to the valve.

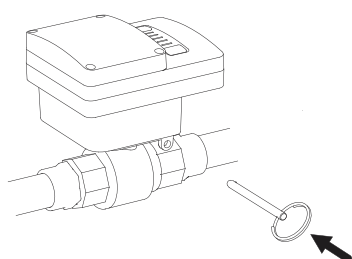

6

Power the valve using the AC adapter. To add an emergency power supply in the event of a power failure, insert 4 AAA lithium batteries (not included).

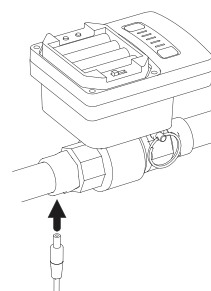

IMPORTANT: Do not insert the batteries before the valve is installed to your main water supply and powered by the supplied adapter.

7

Open the main water supply to make sure there are no leaks.

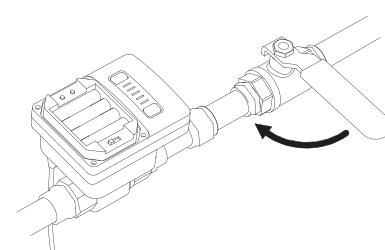

TECHNICAL SPECIFICATIONS

Smart water valve

Ambient temperature: 0 °C to 40 °C [32 °F to 104 °F]

Maximum water temperature: 85 °C [185 °F]

Storage: -20 °C to 50 °C [-4 °F to 122 °F]

Valve body: stainless steel

Controller base: fiberglass reinforced

Maximum pressure: 145 PSI

Maximum torque: 2.5 N.m

Power supply: 5 V / 5 W (included)

Emergency power supply: 4 AAA lithium batteries (not included)

Certifications:

Conforms to CSA B125.3-12 Plumbing fittings

Valve body tested EU RoHS 2 (Directive 2011/65/EU)

Complies with NSF/ANSI51 Standard

Diameter

VA4220WF: ¾ in NPT x ¾ in NPT

VA4221WF: 1 in NPT x 1 in NPT

Wi-Fi: 2.4 GHz (802.11 B/G/N)

Zigbee 3.0 profile

Frequency: 2.4 GHz

Transmission power: +20 dBm

Receiver sensitivity: -108 dBm

Indoor installation only.

Transmitter module IC: 22394-ZBM1501/ FCC ID: 2AK2T-ZBM1501

This device complies with Industry Canada license exempt RSS standard(s).

Operation is subject to the following two conditions:

[1] this device does not cause interference, and [2] this device must accept any interference, including interference that may cause undesired operation of the device.

This equipment has been tested and found to comply with the limits for a Class B digital device, pursuant to part 15 of the FCC Rules. These limits are designed to provide reasonable protection against harmful interference in a residential installation. This equipment generates, uses and can radiate radio frequency energy, and if not installed and used in accordance with the instructions, may cause harmful interference to radio communications. However, there is no guarantee that interference will not occur in a particular installation. If this equipment does cause harmful interference to radio or television reception, which can be determined by turning the equipment OFF and ON, the user is encouraged to try to correct the interference by one or more of the following measures: Reorient or relocate the receiving antenna.

Increase the separation between the equipment and receiver.

Connect the equipment into an outlet on a circuit different from that to which the receiver is connected.

Consult the dealer or an experienced radio/TV technician for help.

Consult the dealer or an experienced radio/TV technician for help.

3-year limited warranty

SINOPÉ TECHNOLOGIES INC. warrants the components of their products against defects in material and workmanship for a 3-year period from the date of purchase, under normal use and service, when proof of purchase of such is provided to the manufacturer. If at any time during the warranty period the product is determined to be defective, SINOPÉ TECHNOLOGIES INC. will replace it. This warranty does not cover any transportation costs that may be incurred by the consumer. Nor does it cover a product that has been improperly installed, misused or accidentally damaged. A water detector's casing that has completely been immersed in water will not be covered by the warranty. The obligation of SINOPÉ TECHNOLOGIES INC., under the terms of this warranty, will be to supply a new unit and this releases the manufacturer from paying the installation costs or other secondary charges linked to replacing the unit or the components. The manufacturer shall not be liable for incidental, consequential, or special damages arising at, or in connection with product use or performance. This warranty does not cover damages or loss caused by defects, and the owner's use of the SINOPÉ TECHNOLOGIES INC. product confirms the understanding that this product does not constitute an insurance policy, and is only a product used to reduce the risk of water damage.

Apple and the Apple logo are trademarks of Apple Inc., registered in the U.S. and other countries. App Store is a service mark of Apple Inc., registered in the U.S. and other countries.

Google Play and the Google Play logo are trademarks of Google Inc.

sinopé

For more information, visit our Website:

www.sinopetech.com

