

sinopé | Pro

Smart thermostat

HVAC

Installation and Configuration Guide

TH6250WF-PRO



Table of contents

Table of contents	2
Included in the box	4
Installation requirements	4
Connections	5
System compatibility	5
Installation and configuration	6
Recommendations	6
Installation - Smart Wi-Fi thermostat TH6250WF-PRO	7
Removing the thermostat from the wall	10
Configuration - Smart Wi-Fi thermostat TH6250WF-PRO	11
Option A - Configuration with the Sinopé Neviweb app	14
Option B - Configuration without Wi-Fi	16
Settings	17
Display options	17
Equipment configuration option	18
Summary of settings	22
System definition	24
Temperature controller	24
Heat pump	24
Electric heating source SSR	25
Dual-energy	25
Accessories	25
Humidifier	25
Dehumidifier	26
Air exchanger	26
User guide	27
Main screen	27
Menu	28
Interface	29
Wi-Fi connection	31
Wi-Fi connection with Sinopé	31
Association with Apple Home	34
Wi-Fi connection via Apple Home	36
Explore more with the Sinopé Neviweb app!	38
Troubleshooting and support	39

Warranty	40
3-year Limited Warranty	40
5-Year Extended Pro Warranty	40
Extended Pro Warranty Terms for Sinopé Pro Products	40
Technical information	41
Smart Wi-Fi thermostat for central systems	42
Mounting plate	43
ISED Canada compliance statement	44
FCC compliance statement	44
Wiring diagrams	45
Conventional system	46
Wiring 1: 1H	46
Wiring 2: 1H	47
Wiring 3: 1C	48
Wiring 4: 1H1C	49
Heat pump	50
Wiring 5: 1H1C	50
Wiring 6: 2H1C	51
Additional system	52
Humidifier / Dehumidifier / Air exchanger	52
Wiring 7: Humidifier, dehumidifier, or air exchanger powered by the HVAC system.	52
Wiring 7.2: Humidifier, dehumidifier, or air exchanger with an independent external power supply	53
Wiring 7.3: Humidifier, dehumidifier, or air exchanger with an independent internal power supply	53
Wiring 8: Dual-energy	54
Wiring 9: SSR	54
Additional accessories	55
Decorative mounting plates	55
AC6500-01 Decorative Mounting Plate (sold separately)	55
Installation diagrams for the AC6500-01 decorative mounting plate	56
AC6500-02 Decorative Mounting Plate (included)	57
Installation diagrams for the AC6500-02 decorative mounting plate	58

Included in the box

Inside the box, you will find:



TH6250WF-PRO thermostat



Mounting plate

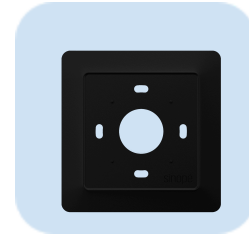

Decorative mounting plate

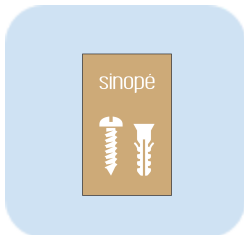

2x screws
2x anchors



Welcome guide

Installation requirements

- **Flathead or Phillips screwdriver** for wall installation of the mounting plate - Phillips #2/slot M7.0
- **Optional** for a more straightforward setup:
 - Wi-Fi connection
 - Smartphone or tablet
 - Sinopé Neviweb account

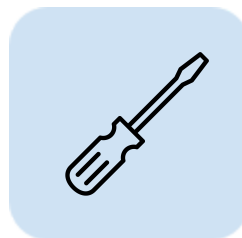

Connections

Connection	Description
C	24 Vac common power supply
R	24 Vac power supply from the heat pump
G	Circulation fan
W	First stage of heating or auxiliary heating for the heat pump
O/B	Reversing valve
Y	First stage of the heat pump or air conditioner
ACC	Connection for accessories. Used to connect additional accessories or external equipment
IN	Dual-Energy input

System compatibility

#	Output / Input	C	R	G	W	O/B	Y	ACC	IN
Conventional system									
1	1H	x	x		x				
2	1H	x	x	x	x				
3	1C	x	x	x			x		
4	1HIC	x	x	x	x		x		
Heat Pump									
5	1HIC	x	x	x		x	x		
6	2HIC	x	x	x	x	x	x		
Additional system									
7	Humidifier/ Dehumidifier/ Air exchanger							x	
8	Dual-energy								x

If the heating source is of the **SSR type** (modulating output, such as an electric baseboard or a coil), please refer to the [wiring diagram #9](#).

Installation and configuration

Recommendations

It is highly recommended that you hire a qualified professional to ensure the safe and effective installation of the HVAC thermostat. Installing these components requires technical expertise and a thorough understanding of the applicable standards in your region.

- **Hire a qualified professional to install the HVAC system.**
- **Ensure system compatibility:** Before any installation, verify that the components are compatible with your existing HVAC system. If in doubt, consult a professional for appropriate advice.
- **Follow applicable standards:** Ensure the installation complies with electrical and plumbing codes and regulations.

By following these recommendations and avoiding potential risks, you can ensure the safe and efficient installation of the HVAC thermostat in your system. For your safety and that of those around you, hire a qualified professional.

Installation – Smart Wi-Fi thermostat

TH6250WF-PRO

- 1** **Switch off the power supply.**
Before installing the thermostat, ensure the breakers for your heating system are off at the electrical panel to avoid the risk of electric shock.

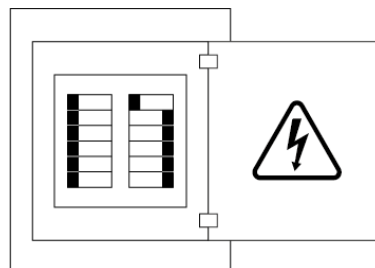

- 2** **Remove the cover of your old thermostat.**
Some covers can be removed by hand, while others need to be unscrewed.

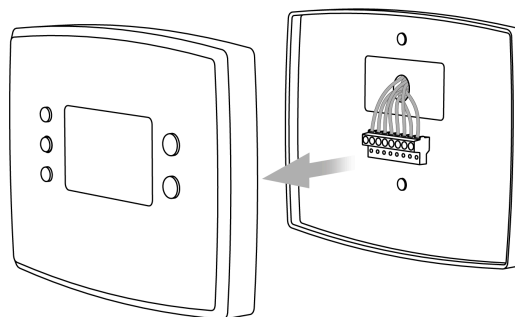

Warning

Check your system's compatibility.

If your old thermostat has a label indicating 120V or 240V or **thick wires with wire nuts**, it is a **high-voltage system**. This system **is not compatible** with the TH6250WF-PRO thermostat.

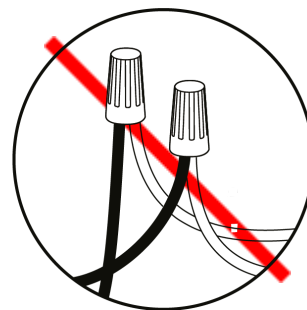

- 3** **Take a photo of the wiring of your old thermostat.**
This photo may help during the installation of your new thermostat.

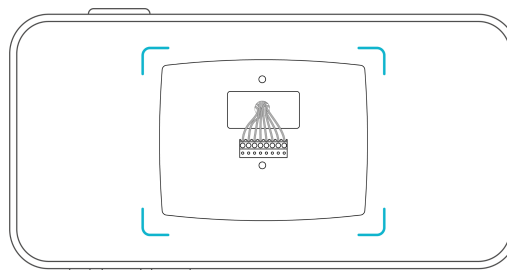

4

Disconnect the wires and remove the base.

After removing the base, we recommend gently wrapping the wires around a pen or pencil to prevent them from falling into the wall hole.

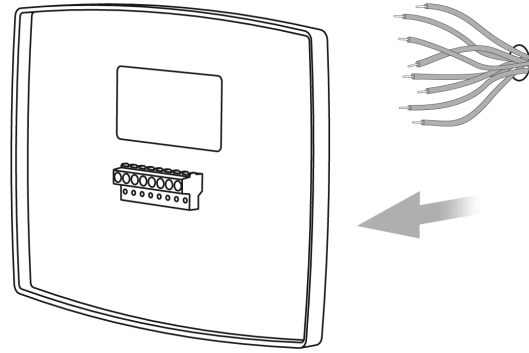

5

Mark the screw locations.

Use the spirit level on the mounting plate to ensure the thermostat is straight.

Installation Tip

When using the decorative mounting plate ([AC6500-01](#) or [AC6500-02](#)) to cover holes or marks left by a previous thermostat, install the decorative plate on the wall first. Then, attach the thermostat's wall plate on top.

⚠ Important note

If the installation includes a junction box, the decorative plate is **mandatory** to ensure **proper and safe coverage**.

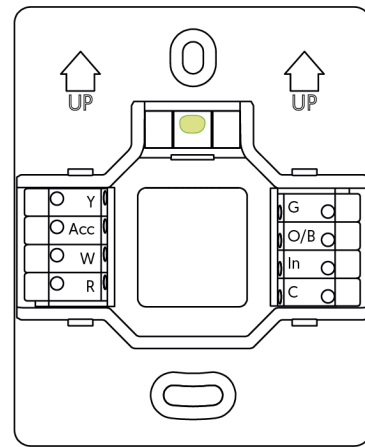

6

Attach the mounting plate.

Feed the wires through the center of the base and secure it to the wall using the provided screws. Use anchors if needed.

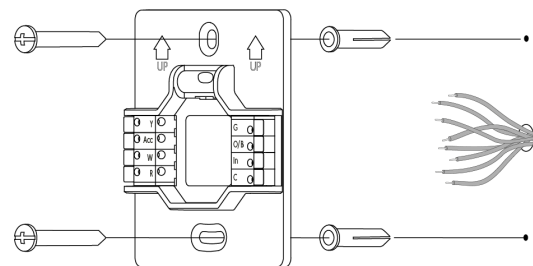

7

Connect the wires

Insert each wire fully into the connector.

Once all wires are properly connected, carefully tuck them into the wall cavity

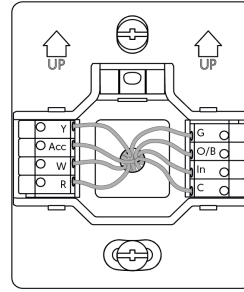

IMPORTANT

1. Insert the wires **through the sides** of the terminals, **not from the top**.

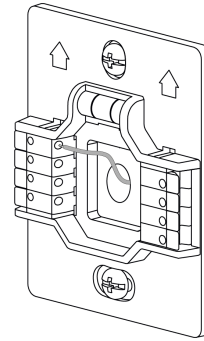

2. Carefully arrange the wires inside the wall so that they do not extend beyond the terminal block.

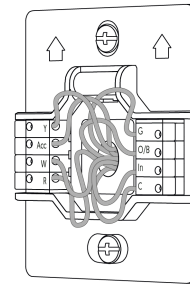
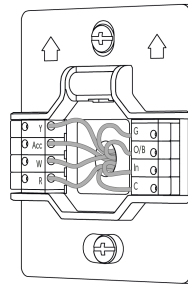

8

Attach the thermostat

Align the thermostat with the wall plate and press it firmly until it clicks into place.

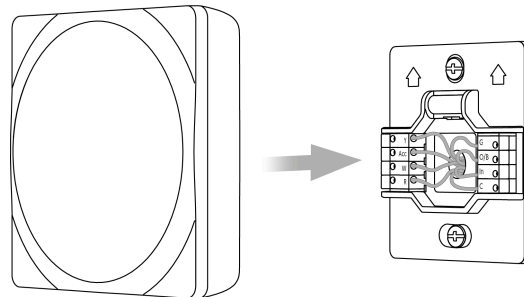

9

Restore power

Turn the circuit breaker back **ON** to power up the thermostat.

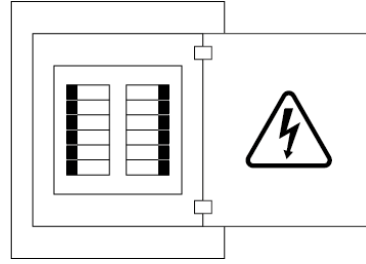

Removing the thermostat from the wall

To remove the thermostat from its wall base, follow these steps:

1. **Preparation:** Ensure you have a firm grip on both sides of the device.
2. **Removal:** Gently but firmly pull the thermostat toward you. The unit should snap off from the wall-mounted base.

! Warning

Never insert any object (screwdriver, knife, or other tool) into the slots located under the thermostat to pry it off. This may cause serious damage to the device's internal components.

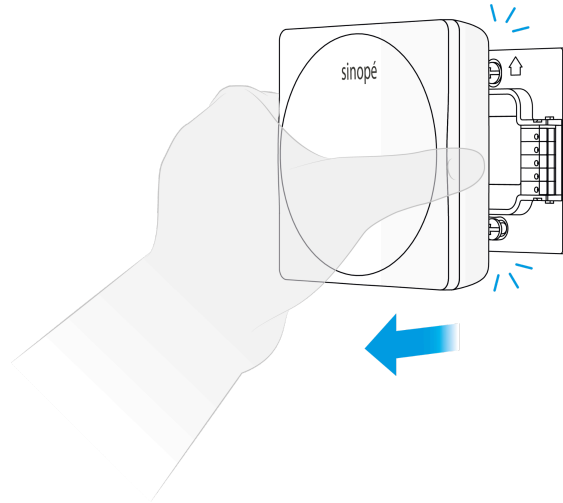

Configuration - Smart Wi-Fi thermostat TH6250WF-PRO

Once the thermostat is powered, the startup screen will briefly appear. Then, follow the steps below to configure it.

Startup screen



1

Language selection

Select the language displayed on your thermostat.



2

Temperature unit

Select the temperature format displayed on the thermostat screen.



3

Connections detected

Select the wires connected to the thermostat.

If the  symbol appears on a tile, click it to view error code details and learn how to fix the problem. If necessary, contact our [Support team](#).

Tip: Refer to the photo taken during the thermostat's installation.

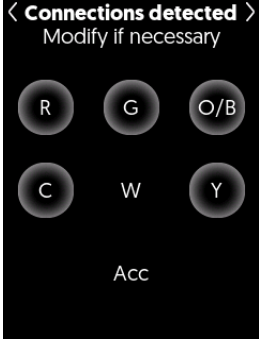

4

Accessories

Select your accessory, if applicable.

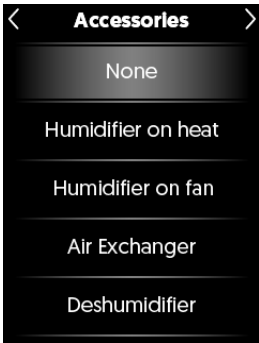

5

Reversing valve*

Determine whether the heat pump reversing valve is activated in cooling or heating mode.

* This screen is only available if the O/B wire is connected.

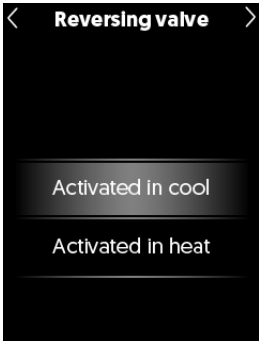

6

Balance point

Select the outdoor temperature above which your heat pump becomes ineffective.



7

Installation type *

Select the type of installation for your equipment

Add-On: If the auxiliary system is activated, the heat pump will be deactivated.

Conventional: The auxiliary system and heat pump can operate simultaneously.

* This screen is only available if the O/B wire is connected.



8

Your thermostat's basic configuration is now complete.

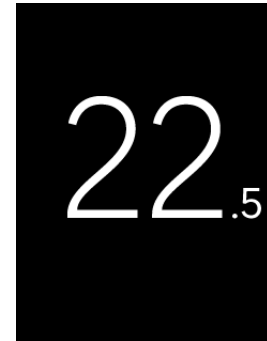

Two options are available for the next steps:

- A. Download the Sinopé Neviweb app to complete the configuration of your thermostat using your smartphone.



- B. Navigate the various equipment configuration menu settings to complete the installation.

Option A - Configuration with the Sinopé Neviweb app

The Sinopé Neviweb app allows you to access all the features of your smart thermostat.

1 Tap the thermostat screen to begin.

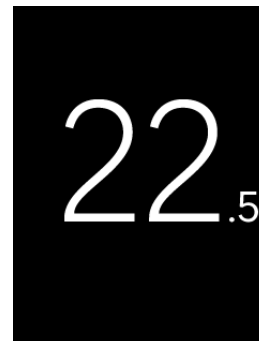

2 Tap the **Settings** icon (⚙️) to access the thermostat settings.

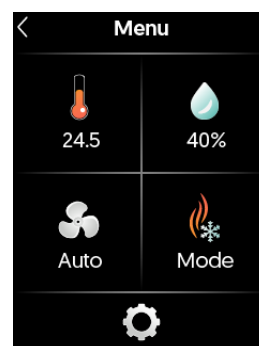

3 In the **Settings** menu, select **Wi-Fi connection**.

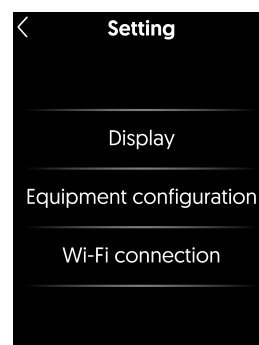

4

Select Sinopé as the configuration platform.

By choosing the **Sinopé Neviweb app**, you will be able to:

- Configure all your thermostat settings from your smartphone
- Display weather information directly on the thermostat screen
- Access advanced features within the Neviweb platform

You can also add your device to **Apple Home** later, if desired.

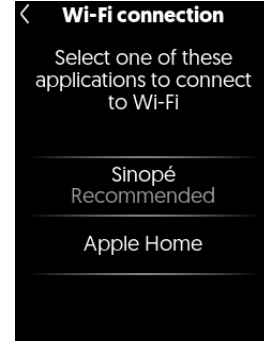

5

Follow the on-screen instructions to complete the Wi-Fi connection.

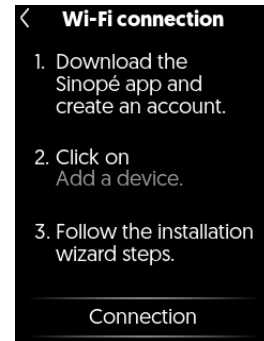

6

Once the Wi-Fi connection is complete, **tap the thermostat tile** in the Sinopé Neviweb app.

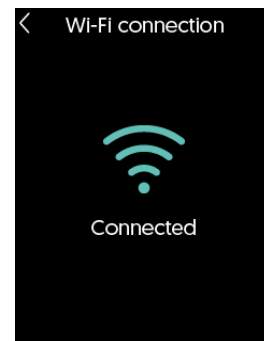

7

Configuring Settings in the App

In the app, tap the Settings icon (⚙️) to access the device settings.

Continue configuring your system by adjusting your preferences in the various menus.

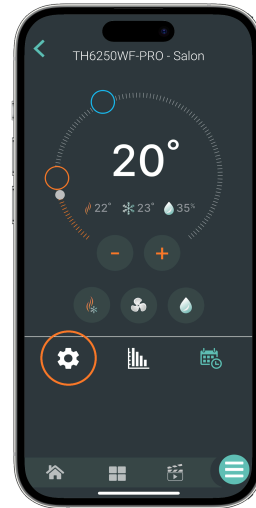

Option B – Configuration without Wi-Fi

Several settings of your new thermostat can be configured directly from its interface.

1

Tap the thermostat screen to begin.

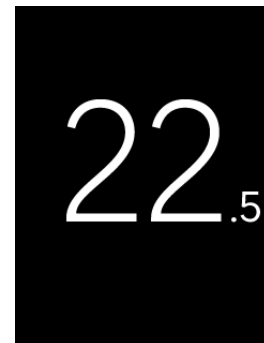

2

Tap the **Settings** icon (⚙️) to access the thermostat settings.

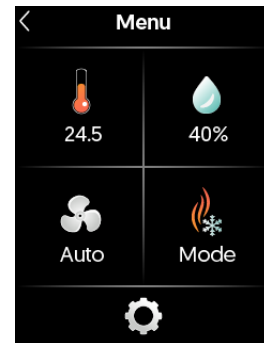

- 3 In the **Settings** menu, select a submenu to customize the device.

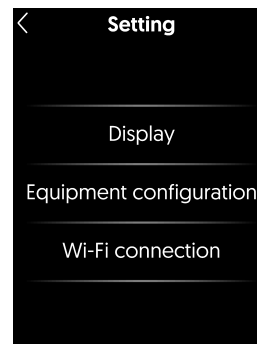

Settings

Display options

Default value in **bold**.

Settings	Description	Options
Temperature unit	The temperature format displayed on the thermostat.	Celsius Fahrenheit
Language	Language displayed on your thermostat.	Français English

Equipment configuration option

Some settings may not be available on your thermostat. Access to these settings varies depending on your system.

Warning: We recommend that the configuration be performed by a professional.

Default value in **bold**.

Settings	Description	Options
Heating source W	Type of energy used for heating source W. <ul style="list-style-type: none"> • Electric: System powered by electricity. • Fossil: System powered by a fossil fuel, such as gas or fuel oil. 	Electric Fossil
Auxiliary heating source*	Type of energy used for the auxiliary heating source <ul style="list-style-type: none"> • Electric: System powered by electricity. • Fossil: System powered by a fossil fuel, such as gas or fuel oil. • SSR: Heating system using a semiconductor relay. <p>*If you have an electric baseboard heater equipped with a non-SSR relay, select the "Fossil" option instead of "Electric."</p>	Electric Fossil Electric SSR
Reversing valve	Determine if the heat pump reversing valve is activated in cooling or heating mode.	Activated in cool Activated in heat
Accessories	Select your accessory, if applicable.	None Humidifier on heat Humidifier on fan Air exchanger Dehumidifier
Heat dissipation time	A delay that allows hot air remaining in the ducts to be evacuated after the system has been shut down.	1 min 2 min 3 min 4 min 5 min Off
Cool dissipation time	A delay that allows cold air remaining in the ducts to be evacuated after the system has been shut down.	1 min 2 min 3 min 4 min 5 min Off
Cooling cycle length in Y	The thermostat adjusts the control band to achieve the desired cooling cycle length. A shorter cycle will increase your comfort but will also increase the wear of your equipment.	25 min 20 min 15 min 10 min

Settings	Description	Options
Heat pump cycle length	The thermostat adjusts the control band to achieve the desired cycle length of your heat pump. A shorter cycle increases your comfort but accelerates wear and tear on your equipment.	25 min 20 min 15 min 10 min
Heat cycle length in W	The thermostat adjusts the control band to achieve the desired heating cycle length. A shorter cycle will increase your comfort but will also increase the wear of your equipment.	25 min 20 min 15 min 10 min ^{1*}
Auxiliary cycle length	The thermostat adjusts the control band to achieve the desired heating cycle length. A shorter cycle will increase your comfort but will also increase the wear of your equipment. If you use an SSR heating source and select a 15-second delay, ventilation will not be activated (e.g., baseboard). If you select a 1-second delay, ventilation will be activated according to the requested mode (e.g., duct heater).	25 min 20 min 15 min 10 min 1 sec ** 15 sec **
Heating/Cooling setpoint Delta T°	The minimum temperature delta authorized between the heating and cooling setpoints. Only applies in AUTO mode.	1 °C 2 °C 3 °C 4 °C 5 °C
Balance point	The outdoor temperature at which the heat pump becomes inefficient.	-30 °C to 0 °C Off Default: -15 °C
Air curtain²	Adjust the output of SSR heating systems (e.g., electric baseboard) according to the outdoor temperature – the colder it is, the higher the output – to avoid the sensation of cold near windows. Outdoor temperature Activation: The outdoor temperature at which the SSR heating source activates at minimum output. Outdoor temperature -Maximum power: Outdoor temperature at which the SSR heating source reaches full power.	Off Outdoor T° Activation: 0° C Outdoor T° Max. power: -50° C Option: 10° C to -50° C
Installation type	The installation type of your equipment Add-On: If the auxiliary system is activated, the heat pump will be deactivated. Conventional: The auxiliary system and heat pump can operate simultaneously.	Add-On Conventional

¹* Available only when the selected heating source is electric

** Available for SSR heating source only

² Available if an SSR heating source is selected.

Settings	Description	Options
Temperature calibration	Temperature offset needed to compensate for the inaccuracies between the thermostat temperature reading and the ambient temperature.	2 °C 1.5 °C 1 °C 0.5 °C 0 °C -0.5 °C -1 °C -1.5 °C -2 °C
Compressor min. run time	Minimum time for which the compressors will be active before they can be switched off.	2 min 3 min 4 min 5 min 10 min
Compressor min. off time	Minimum time the compressor must be switched off before restarting.	2 min 3 min 4 min 5 min 10 min
Auxiliary heating min. run time	Minimum time the auxiliary heater will run before it can be switched off.	2 min 3 min 4 min 5 min 10 min
Heating min. off time	Minimum time the main heater must remain off.	2 min 3 min 4 min 5 min 10 min
Auxiliary heating min. off time	Minimum time auxiliary heater must remain off.	2 min 3 min 4 min 5 min 10 min
Heat pump try time	The period for which the heat pump is used to regulate the temperature before the auxiliary heat stage can be activated.	30 min 1 h 2 h 3 h 4 h 5 h 6 h 7 h 8 h

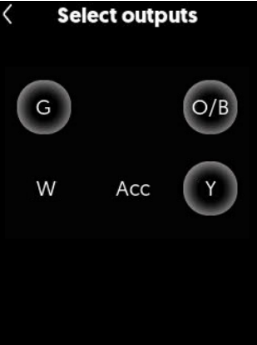
Settings	Description	Options
Polarity W	The polarity setting for output W allows you to define whether the output is normally open or normally closed.	Normally open Normally closed
Equipment testing	<p>This tool allows the installer to test the equipment. Testing should be conducted by a qualified professional. Improper testing could damage the equipment.</p> <p>Pressing 'Continue' will display the available outputs. The professional can then select one or more outputs. The system will activate automatically based on the selected outputs. To end the test, press the output again to deactivate it.</p> <p>If the  symbol appears on a tile, click it to view error code details and learn how to fix the problem. If necessary, contact our Technical Support team.</p>	
Diagnostic	This page displays various information that may be useful if you need to contact our Technical Support team. No configuration is possible from this screen.	
Factory reset	<p>Two possible options:</p> <p>Equipment configuration: Resets equipment-specific parameters and wire configuration. Other parameters, such as temperature format, setpoints, schedules, and Wi-Fi connection, will remain unchanged.</p> <p>Device Reset: Resets all custom data and previous settings, allowing the user to restart the installation process from scratch.</p>	

Summary of settings

	TH6250WF- PRO	Sinopé app
Display		
Temperature unit	X	
Language	X	
Device Configuration		
Temperature unit	X	X
Language	X	X
Time format		X
Screen brightness		X
Screen access		X
Filter change reminder		X
Away heating setpoint		X
Away cooling setpoint		X
Dual-energy optimization - Éco Sinopé		X
Accessory optimization - Éco Sinopé		X
Maximum setpoint heating		X
Minimum setpoint heating		X
Maximum setpoint cooling		X
Minimum setpoint cooling		X
Early start		X
Do not allow heating if the outside temperature is above X°C.		X
Do not allow cooling if the outside temperature is below X°C.		X
Equipment configuration		
Heating source W	X	X
Auxiliary heating source	X	X
Reversing valve	X	X
Accessories	X	X
Heat dissipation time	X	X
Cool dissipation time	X	X
Cooling cycle length Y	X	X
Heat pump cycle length	X	X
Heating cycle length W	X	X
Auxiliary heating cycle length	X	X
Heating/Cooling setpoint Delta	X	X

	TH6250WF- PRO	Sinopé app
Installation type	X	X
Balance point	X	X
Air curtain	X	X
Temperature calibration	X	X
Compressor min. run time	X	X
Compressor min. off time	X	X
Auxiliary heating min. run time	X	X
Heating min. off time	X	X
Auxiliary heating min. off time	X	X
Heat pump try time	X	X
Polarity W	X	X
Equipment testing	X	
Diagnostic	X	
Factory reset	X	

System definition

Temperature controller

The TH6250WF-PRO uses an adaptive deadband controller with a programmable cycle length. The thermostat's control band automatically adjusts to achieve the desired cycle length for your system.

Note: The control band represents the range between the room's maximum and minimum temperatures when the system operates at 50% power, which directly affects comfort.

Since different cycle lengths can be set for primary heating, auxiliary heating, and cooling, the thermostat adjusts to optimize each mode. The thermostat may require several control cycles to reach optimal values. Once optimized, the thermostat saves the optimal value so it can immediately determine which control band to use upon mode change or a product restart. The cycle length is 15 minutes by default, but this setting can be changed in the advanced configuration menu.

For example, a thermostat set to a 15-minute cycle may initially only achieve an 18-minute cycle at startup. The thermostat will adjust the control band until the desired cycle time is reached.

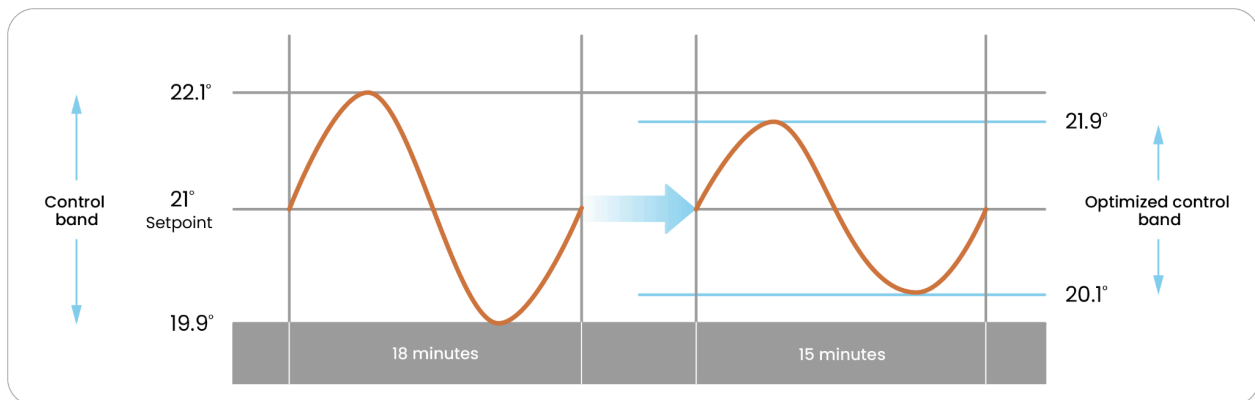

Although it may be tempting to set a very short control cycle to increase comfort, this approach should not be prioritized. It is essential to set the control cycle according to the installed equipment. Subsequently, the thermostat will automatically optimize the control band to maximize comfort.

Heat pump

The thermostat supports up to 2 heating stages (1 heat pump stage and 1 auxiliary heating stage), 1 cooling stage, a fan, and an accessory.

The thermostat activates the auxiliary heating stage only if the room temperature exceeds twice the control band (calculated by the thermostat's adaptive controller; see the 'Temperature controller' section) for longer than the **'Heat Pump Try Time'**, an adjustable parameter in the advanced settings.

This feature prioritizes heat pump use while providing freeze protection in the event of failure. If the outdoor temperature drops below the adjustable 'Balance Point' in advanced settings, the heating switches to auxiliary heating, and the heat pump is stopped.

Electric heating source SSR

To avoid wide temperature variations, the thermostat can be configured with a rapid control cycle for secondary heating, either for an electric baseboard (15 seconds) or a coil (1 second). This type of installation requires an SSR-type electronic relay. Refer to [wiring diagram #9](#).

Dual-energy

The '**IN**' input is compatible with dual-energy systems. It can be connected to a dry contact from a dual-register electric meter or any other device requiring auxiliary heating.

To use this feature, an auxiliary heating output must be available. When the dual-energy input is activated, the thermostat will use only the heating source connected to the auxiliary heating stage.

Accessories

If you connect an accessory to the '**ACC**' output, it is important to select the thermostat's control mode correctly during installation. You can always adjust it later in the equipment configuration menu.

Humidifier

If you have a bypass humidifier, whether pad- or drum-type, you must select '**Humidifier on Heat**' in the accessory settings. The thermostat will activate the humidifier water valve only when the heating is running and humidification is needed. This ensures proper distribution of water vapor and prevents condensation in the ducts.

If you have a steam humidifier, select '**Humidifier on Fan**' in the accessory settings. The thermostat will activate the humidifier only when ventilation is active and humidification is needed.

The thermostat offers two humidity management modes: **Automatic** and **Manual**.

- **Manual mode:** Allows you to manually select the desired humidity level (in %). The system will maintain this level regardless of the outside temperature.
- **Automatic mode:** The humidity level is automatically adjusted based on the outside temperature. This approach optimizes comfort while reducing the risk of condensation, particularly on windows during cold periods. The curve used to determine the humidity percentage in automatic mode is based on the following reference: *ASHRAE HVAC Handbook, Chapter 22 - Table 1: Maximum Relative Humidity in a Space for No Condensation on Windows*³.

³ https://www.ashrae.org/file%20library/technical%20resources/covid-19/si_s20_ch22.pdf

You can also apply an offset in **Auto mode** to lower the target humidity level further, helping to prevent excessive condensation.

Auto and **Manual** mode management is also available for **dehumidification** and the **air exchanger**.

Dehumidifier

A dehumidifier can be connected to the thermostat to control the home's humidity level. The ventilation and dehumidifier will activate simultaneously. The option of manual or automatic control also applies to the humidifier.

Air exchanger

After selecting this accessory, you can force air exchange from the home menu by choosing one of the following options:

Option	Description
OFF	No air exchange
20 min/h (default)	20 min air exchange every hour
40 min/h	40 min air exchange every hour
Continuous	Continuous air exchange

The air exchanger can also be used to **control humidity levels**. If the humidity inside the home is too high and outdoor conditions allow, the exchanger will be activated to dehumidify the air based on the set point defined in the parameters—either in automatic or manual mode, as mentioned above.

User guide

Main screen



Note: The outdoor temperature, weather conditions, and time are available if the thermostat has been added to the Sinopé application.

Menu

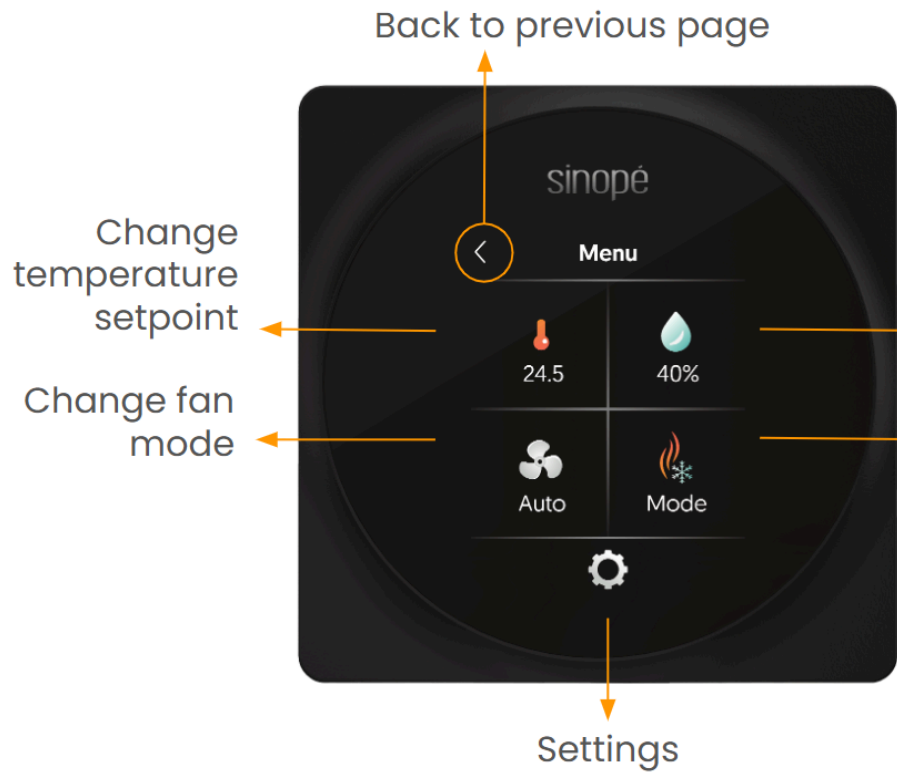
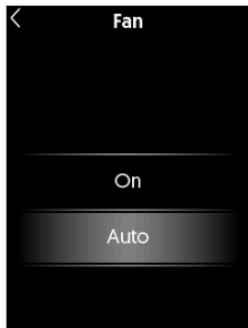
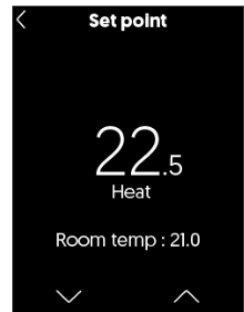

Modify the status of your accessory
If no accessory is connected, only the humidity level in the home will be displayed.

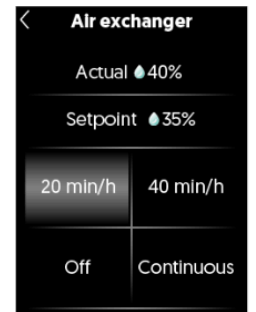

Change modes
The modes displayed may vary depending on the system.

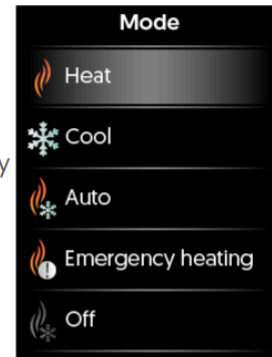

Interface



Your system is currently cooling



Your system is currently heating



Your system is in auxiliary heating mode



Your system is in dual-energy mode



Your device takes part in a peak event



Thermostat: Wi-Fi connection lost



An error is detected. Press the screen to obtain details



Outdoor temperature settings prevent system activation

Wi-Fi connection

You can connect your thermostat to Wi-Fi in two ways:

- Set up with **Sinopé**
- Set up with **Apple Home**

We recommend starting with the setup through the Sinopé Neviweb app. This platform lets you easily configure all your thermostat settings on your smartphone. Additionally, the Sinopé Neviweb app lets you display weather conditions on the screen and access various platform features. Later on, you can also add your device to Apple Home.

Wi-Fi connection with Sinopé

1 Tap the thermostat screen to begin.

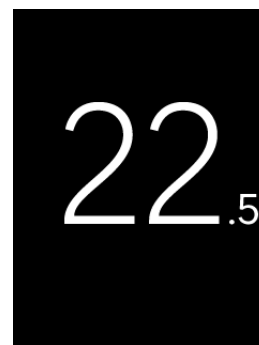

2 Tap the **Settings** icon (⚙️) to access the thermostat settings.

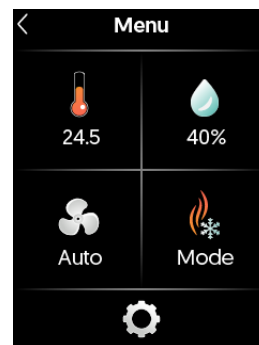

3 In the **Settings** menu, select **Wi-Fi connection**.

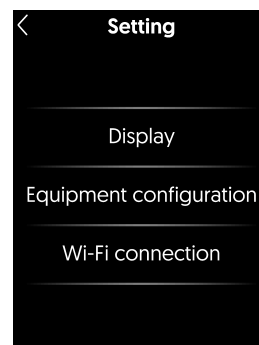

4

Select Sinopé as the configuration platform.

By choosing the **Sinopé Neviweb app**, you will be able to:

- Configure all your thermostat settings from your smartphone
- Display weather information directly on the thermostat screen
- Access advanced features within the Neviweb platform

You can also add your device to **Apple Home** later, if desired.

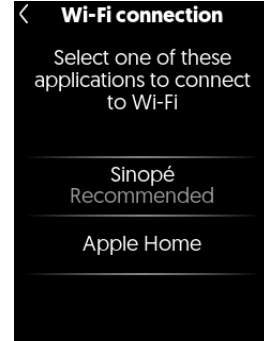

5

Follow the on-screen instructions to complete the Wi-Fi connection.

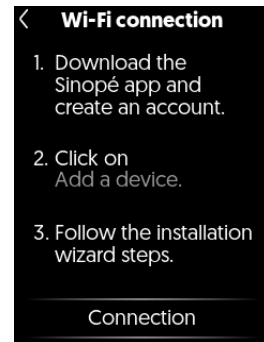

6

Once the Wi-Fi connection is complete, **tap the thermostat tile** in the Sinopé Neviweb app.

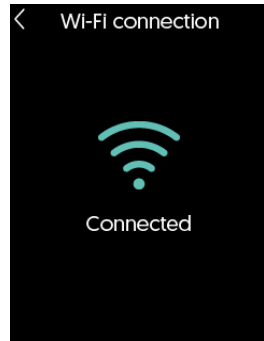

7

Configuring Settings in the App

In the app, tap the Settings icon (⚙️) to access the device settings.

Continue configuring your system by adjusting your preferences in the various menus.

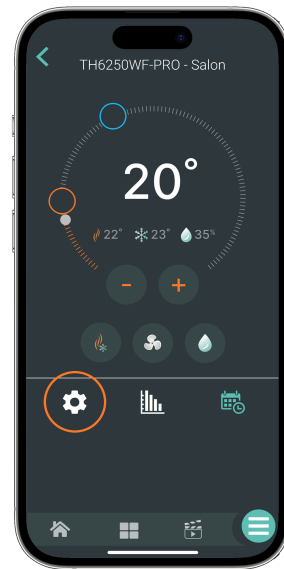

Association with Apple Home

If you have already connected your device via Sinopé and now want to add it to Apple Home, please follow the steps below:

1 Tap on the main screen to access the menu.

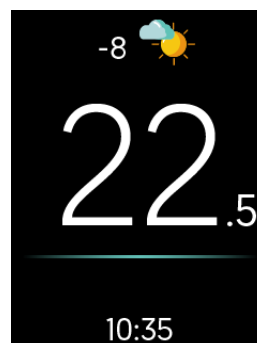

2 Tap the **Settings** icon (⚙️) to access the thermostat settings.

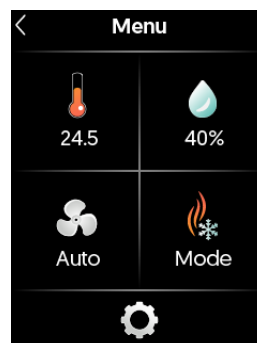

3 In the **Settings** menu, select **Wi-Fi connection**.

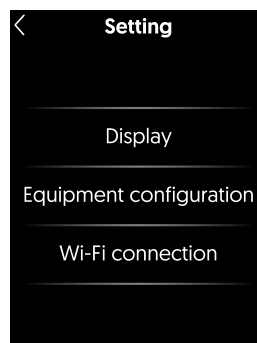

4

Then tap on '**Apple Home Configuration.**'

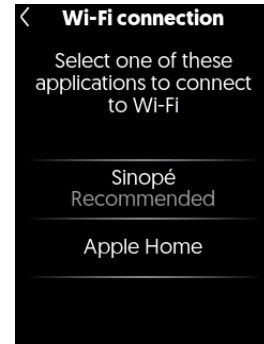

5

Follow the on-screen steps and tap '**Connection.**'

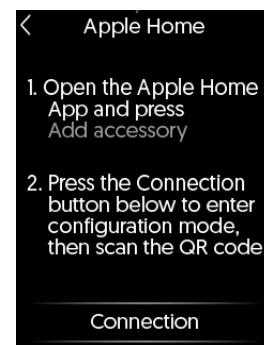

6

Follow the steps displayed on the screen.

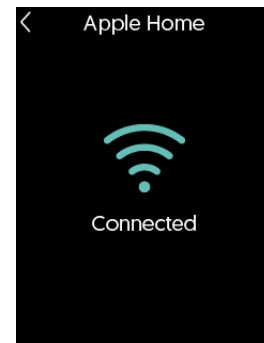
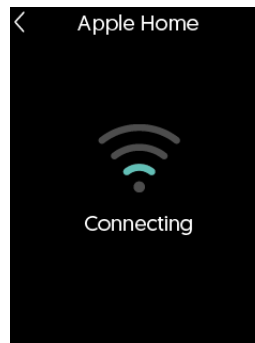

7

Tap **the arrow in the top left corner** to exit the connection menu.



Wi-Fi connection via Apple Home

1

Tap the thermostat screen to begin.

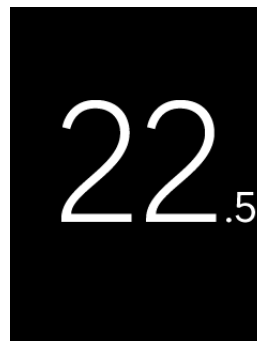

2

Tap the **Settings** icon (⚙️) to access the thermostat settings.

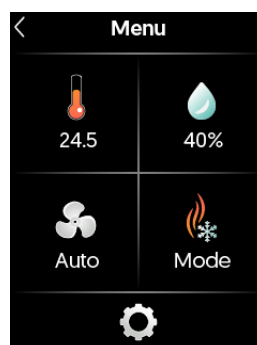

3

In the **Settings** menu, select **Wi-Fi connection**.

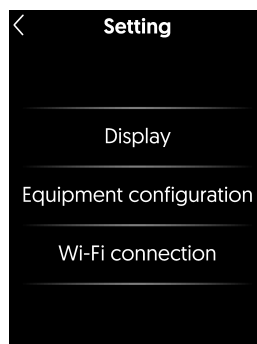

4

Tap on "**Apple Home**."

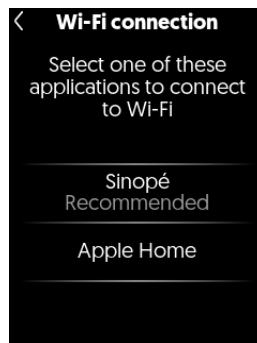

5

Follow the on-screen steps and tap **'Connection'**.

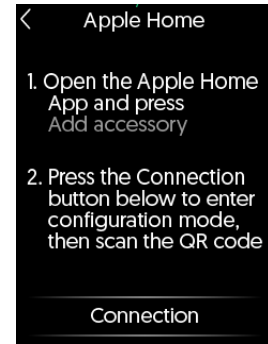

6

Follow the steps displayed on the screen.

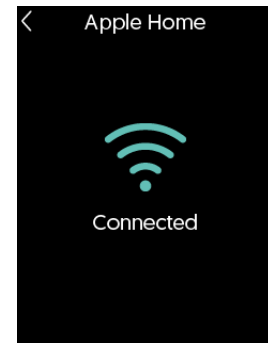
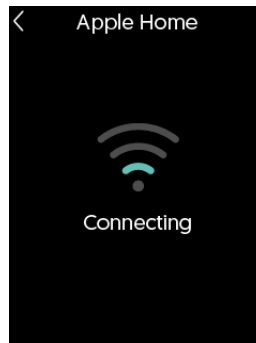

7

We recommend continuing the setup and adding your thermostat to the **Sinopé Neviweb** application.

This platform lets you easily adjust **all thermostat settings** directly from your smartphone.

Additionally, the Sinopé Neviweb app allows you to display weather conditions on the thermostat's screen and access additional features.

Tap **'Get Started'** and follow the on-screen instructions.

Tap the arrow in the top left corner to return to the main page.



Automatic and away-from-home control of this HomeKit-compatible accessory requires a HomePod, Apple TV, or iPad set up as a Home Hub. It is recommended that the software and operating system be updated.

Using the *Works with Apple* badge means that an accessory has been designed to work specifically with the technology identified in the badge and has been certified by the developer to meet Apple's performance standards. Apple is not responsible for the operation of this device or its compliance with safety and regulatory standards.

HomeKit is a trademark of Apple Inc.

Explore more with the Sinopé Neviweb app!

The Sinopé Neviweb application, developed by Sinopé Technologies, a company specializing in smart device design and the largest Canadian manufacturer of such devices for residential and multi-residential sectors, offers comprehensive management of your smart devices.

Sinopé Neviweb is a consumer application for managing various devices, including other thermostats, switches, dimmers, and water damage protection systems.

Discover additional features available in the Sinopé Neviweb app for the **smart thermostat**:

- **Schedule filter change reminders:** Ensure indoor air quality.
- **Adjust screen brightness:** Tailor the screen's responsiveness to your preferences.
- **Screen access control:** Explore different access levels to restrict access for children or in commercial settings.
- **Change the time display format.**
- **Customize setpoints:** Adjust settings based on your schedules and geofencing.
- **View energy consumption graphs.**
- **Add devices to Éco Sinopé:** Optimize energy consumption during peak events.

Troubleshooting and support

If you encounter any difficulties during the installation or operation of the thermostat, the Sinopé application, or when connecting to other platforms, we invite you to consult Sinopé's support website by visiting <https://support.sinopetech.com/en/>.

The technical support team will be happy to assist you.

Call us at :

1 (855) 741-7701

Write to us at:

support@sinopetech.com

Find us at :

705 Montrichard Avenue
Saint-Jean-sur-Richelieu
Quebec, Canada (J2X 5K8)

Opening hours :

Monday to Friday - 8:00 am to 4:30 pm (EST)
Saturday & Sunday - Closed

Warranty

3-year Limited Warranty

SINOPÉ TECHNOLOGIES INC. (“Sinopé”) warrants the components of their products against defects in material and workmanship for a 3-year period from the date of purchase, under normal use and service, when proof of purchase of such is provided to the manufacturer. If, at any time during the warranty period, the product is determined to be defective, SINOPÉ TECHNOLOGIES INC. will replace it. This warranty does not cover any transportation costs that may be incurred by the consumer. Nor does it cover a product that has been improperly installed, misused, or accidentally damaged. The obligation of SINOPÉ TECHNOLOGIES INC., under the terms of this warranty, will be to supply a new unit, and this releases the manufacturer from paying the installation costs or other secondary charges linked to replacing the unit or the components. The manufacturer shall not be liable for incidental, consequential, or special damages arising at or in connection with product use or performance. SINOPÉ TECHNOLOGIES INC. is not required to provide replacement parts or repair services after the warranty period expires.

5-Year Extended Pro Warranty

Extended Pro Warranty Terms for Sinopé Pro Products

SINOPÉ TECHNOLOGIES INC. (“Sinopé”) offers an Extended Pro Warranty for select Sinopé Pro products, subject to the following terms and conditions.

1. **Eligibility:** The Extended Pro Warranty applies exclusively to Sinopé Pro products that are (i) sold by authorized Sinopé Pro installers, and (ii) installed by such authorized Sinopé Pro installers, within the United States and Canada. Products purchased or installed through any other channels or by unauthorized parties are not eligible for this warranty extension.
2. **Activation:** The Extended Pro Warranty is automatically activated upon the successful addition of the eligible Sinopé Pro product to the purchaser’s Sinopé account. Activation requires that the product be purchased and installed by an authorized Sinopé Pro installer. If these conditions are not met, the Extended Pro Warranty will not apply.
3. **Standard Warranty:** Sinopé Pro products purchased from channels other than authorized Sinopé Pro installers, or installed by non-authorized parties, are covered only by the standard three (3) year warranty, which commences from the date of purchase.
4. **General Provisions:** This Extended Pro Warranty is subject to the same limitations, exclusions, and conditions as outlined in Sinopé’s standard warranty terms, unless otherwise specified in these terms. All other terms and conditions not expressly modified herein shall remain in full force and effect.

By purchasing and installing Sinopé Pro products through authorized channels, you agree to the terms and conditions outlined in this Extended Pro Warranty.

Technical information

TH6250WF-PRO

Smart Wi-Fi thermostat for central systems

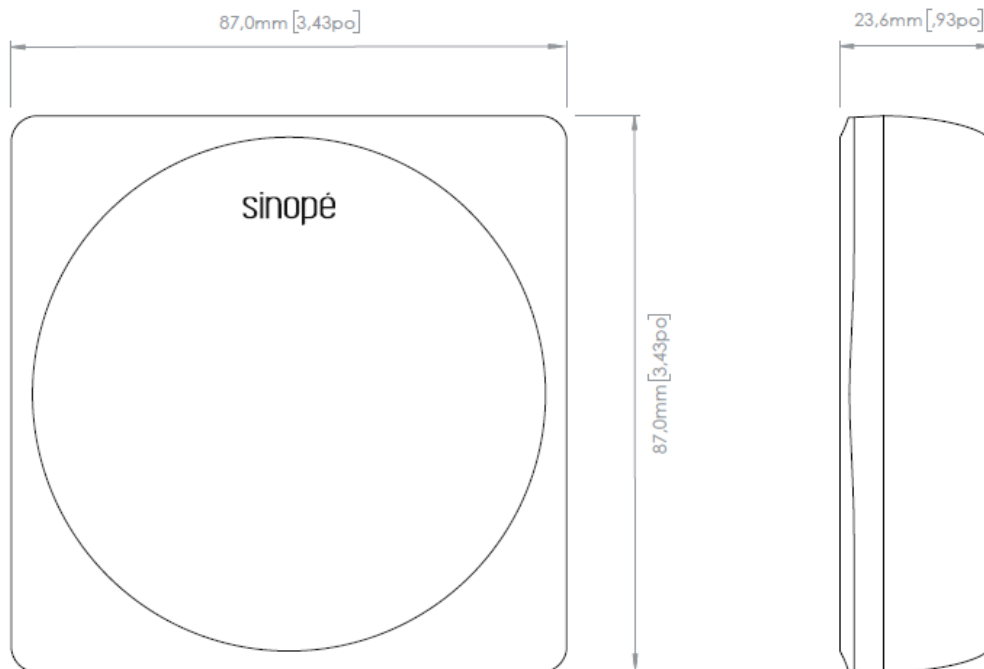

Connectors	See the information on the mounting plate
Power supply	24 Vac
Screen	2.4" color TFT touchscreen 240 x 320 px
Dimensions(W x H x D)	87 mm (3.43 in) x 87 mm (3.43 in) x 23.6 mm (0.93 in)
Operating temperature	0 °C to 50 °C (32 °F to 122 °F)
Storage temperature	-20 °C to 50 °C (-4 °F to 122 °F)
Sensors	Humidity sensor Proximity sensor Light sensor for adaptive display
Communication protocol	Protocol: Wi-Fi Standard: IEEE 802.11 b/g/n Frequency: 2.4 GHz Encryption key: WPA2
Communication module	IC: 21098-ESPC6WROOM1 FCC ID: 2AC7Z-ESPC6WROOM1
Warranty	Basic - 3 years Pro - 5 years

Mounting plate

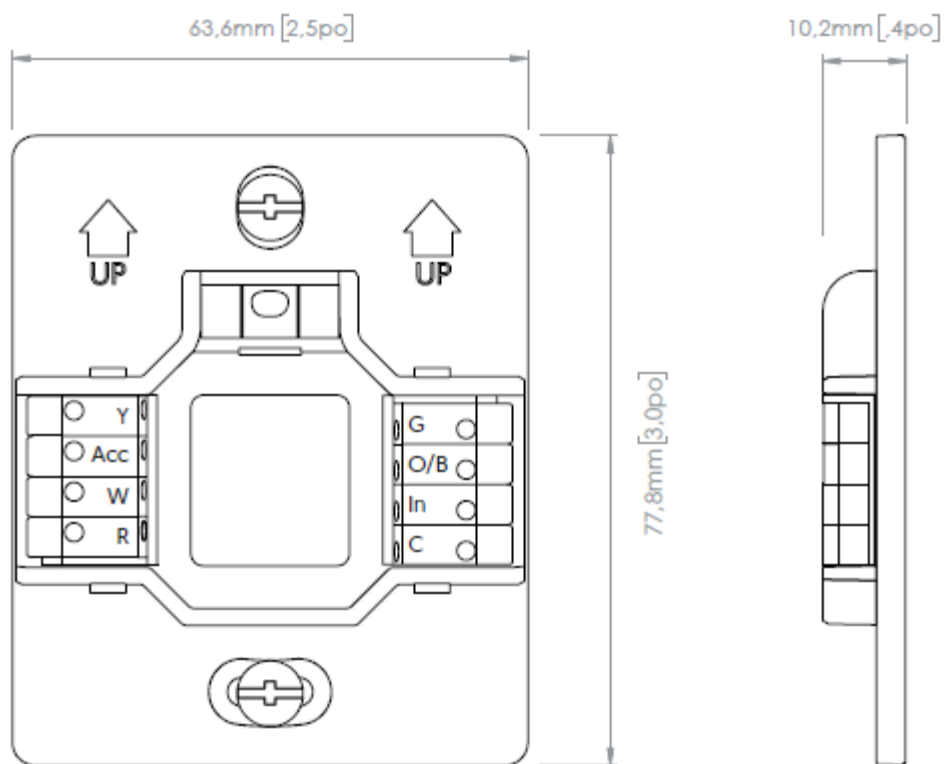

Dimensions (W x H x D)

63.6 mm (2.5 in) x 77.8 mm (3.0 in) x 10.2 mm (0.4 in)

Connectors

8 connectors
Wire range (Solid): 18-22 AWG
Wire range (Stranded): 20-22 AWG

Wire clearance manufacturer's recommendation: 6.5 - 7.0 mm

Controlling this HomeKit-enabled accessory automatically and away from home requires a HomePod, Apple TV, or iPad set up as a home hub. It is recommended that you update to the latest software and operating system. Use of the Works with Apple badge means that an accessory has been designed to work specifically with the technology identified in the badge and has been certified by the developer to meet Apple performance standards. Apple is not responsible for the operation of this device or its compliance with safety and regulatory standards. HomeKit is a trademark of Apple Inc.

Sinopé® is a registered trademark of Sinopé Technologies Inc. in Canada and the United States.

Apple and the Apple logo are trademarks of Apple Inc., registered in the U.S. and other countries. App Store is a service mark of Apple Inc., registered in the U.S. and other countries.

Google Play and the Google Play logo are trademarks of Google Inc.

The Wi-Fi CERTIFIED™ Logo is a certification mark of Wi-Fi Alliance®.

ISED Canada compliance statement

This device contains licence-exempt transmitter(s)/receiver(s) that comply with Innovation, Science and Economic Development Canada's licence-exempt RSS(s). Operation is subject to the following two conditions:

- This device may not cause interference.
- This device must accept any interference, including interference that may cause undesired operation of the device.

FCC compliance statement

This equipment has been tested and found to comply with the limits for a Class B digital device, pursuant to part 15 of the FCC Rules. These limits are designed to provide reasonable protection against harmful interference in a residential installation.

This equipment generates, uses and can radiate radio frequency energy, and if not installed and used in accordance with the instructions, may cause harmful interference to radio communications. However, there is no guarantee that interference will not occur in a particular installation.

If this equipment does cause harmful interference to radio or television reception, which can be determined by turning the equipment OFF and ON, the user is encouraged to try to correct the interference by one or more of the following measures:

- Reorient or relocate the receiving antenna.
- Increase the separation between the equipment and receiver.
- Connect the equipment into an outlet on a circuit different from that to which the receiver is connected.
- Consult the dealer or an experienced radio/TV technician for help.

Wiring diagrams

Conventional system

Wiring 1: 1H

This system refers to a **single-stage heating system without ventilation**. Standard connection for furnaces.

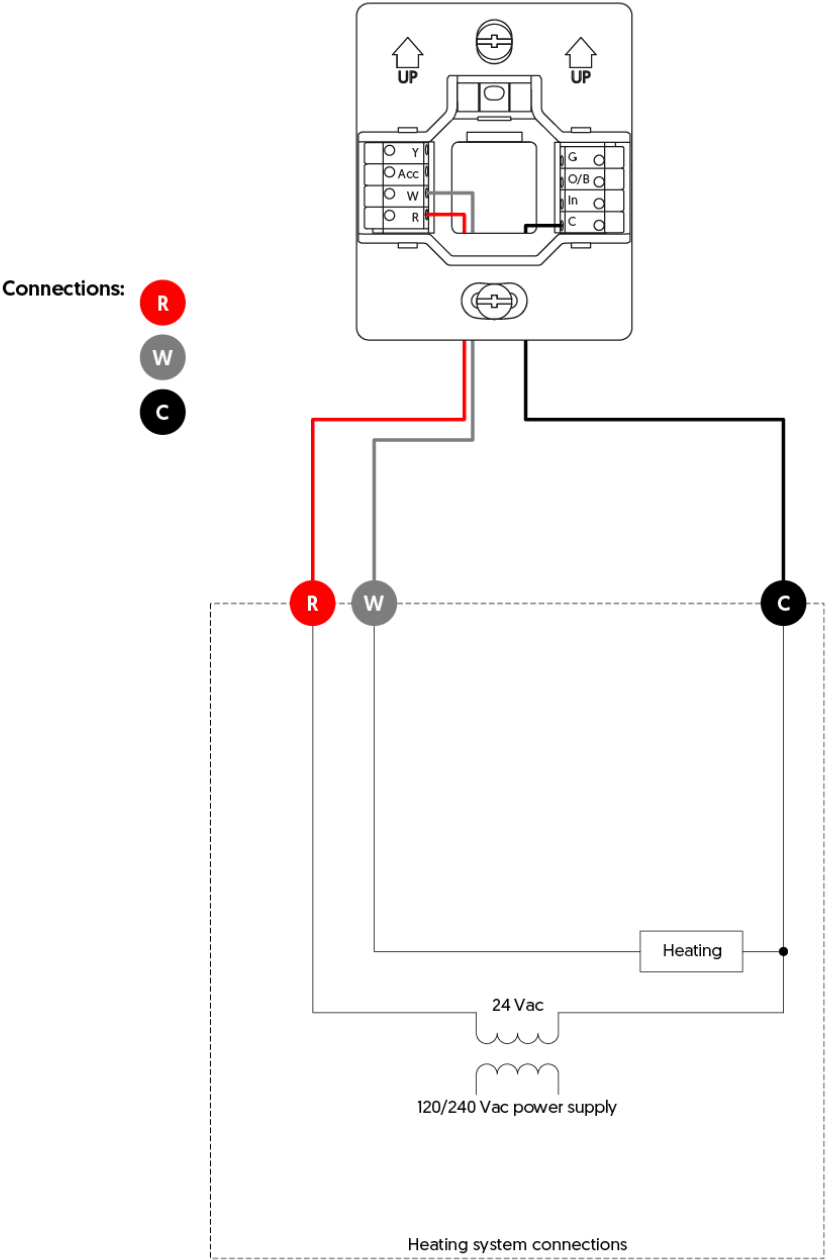

Wiring 2: 1H

This system refers to a **single-stage heating system with ventilation control**. Standard connection for furnaces.

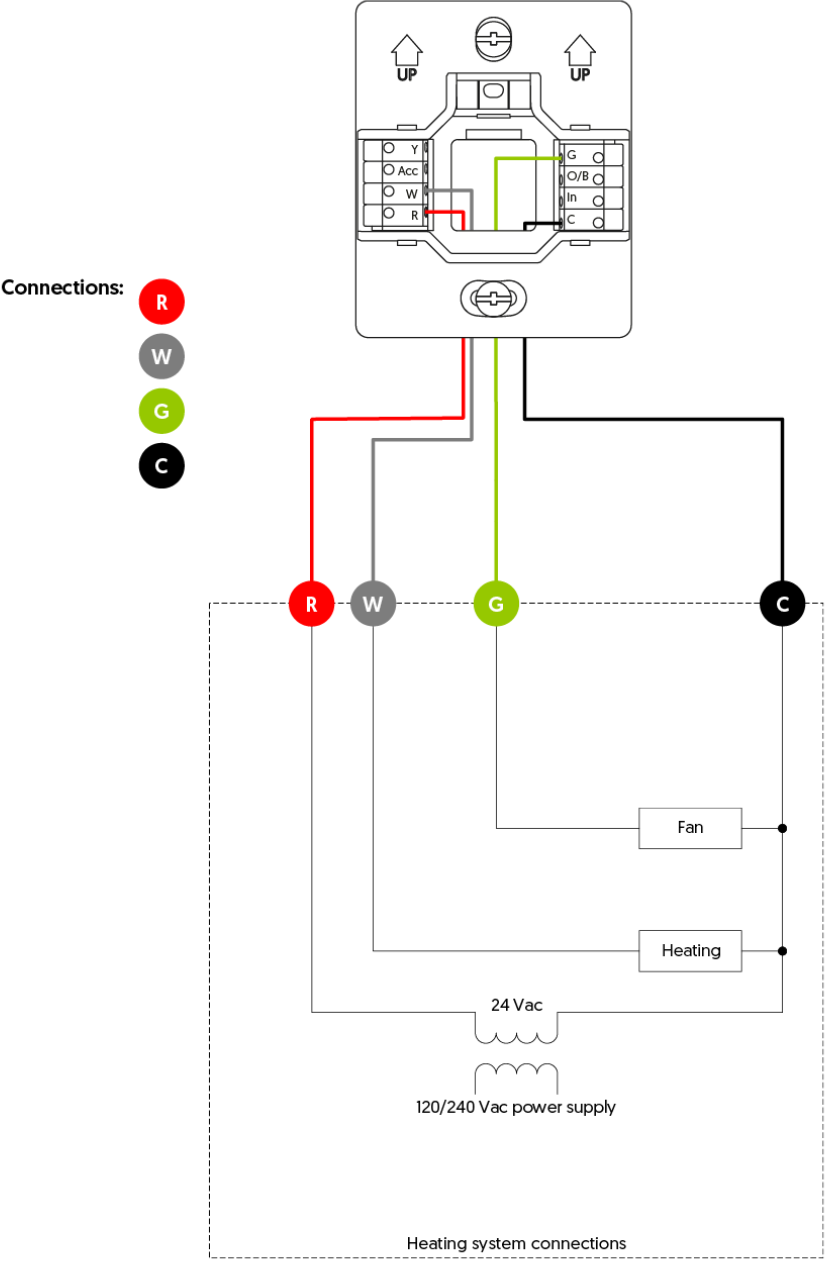

Wiring 3: 1C

This system refers to a **single-stage air conditioning system with ventilation control**. Standard connection for air conditioners.

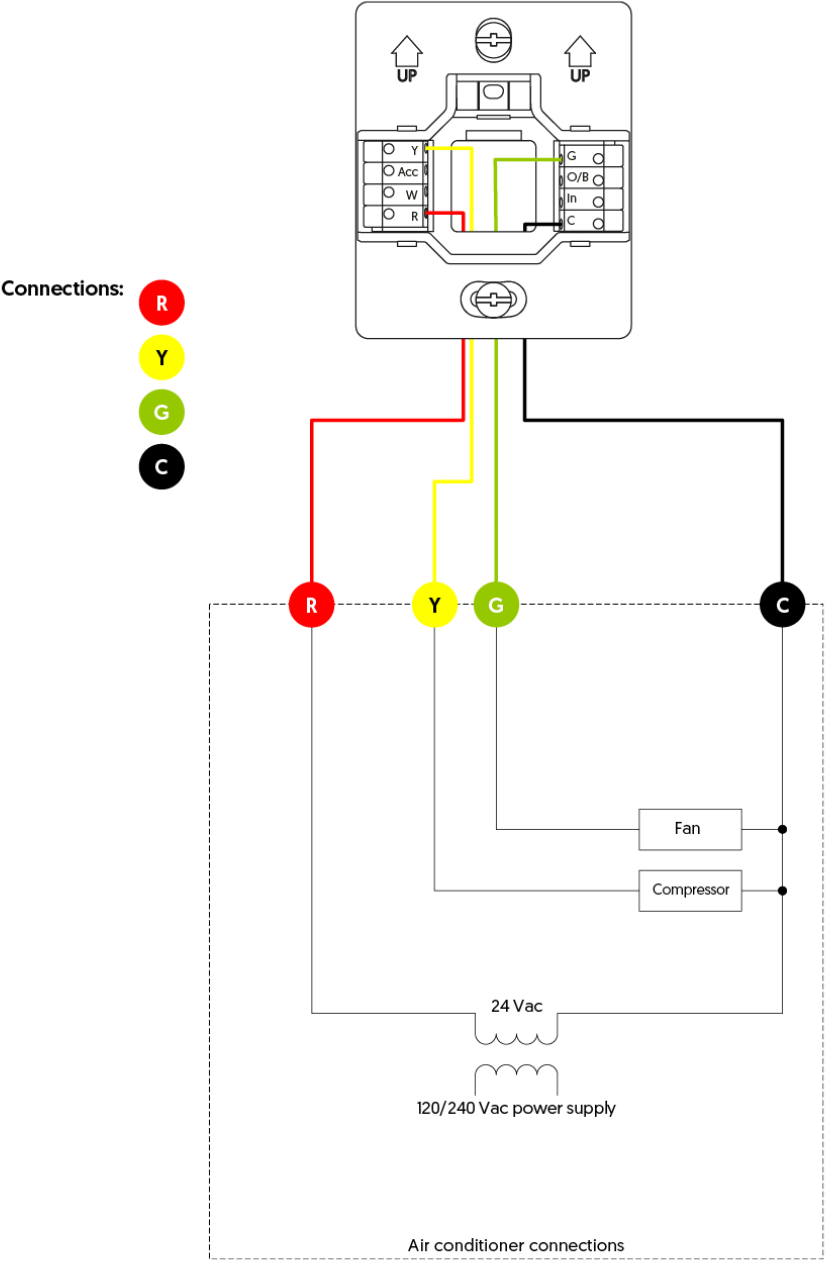

Wiring 4: 1H1C

This system refers to a heating, ventilation, and air conditioning system designed for **a single heating and single cooling stage**.

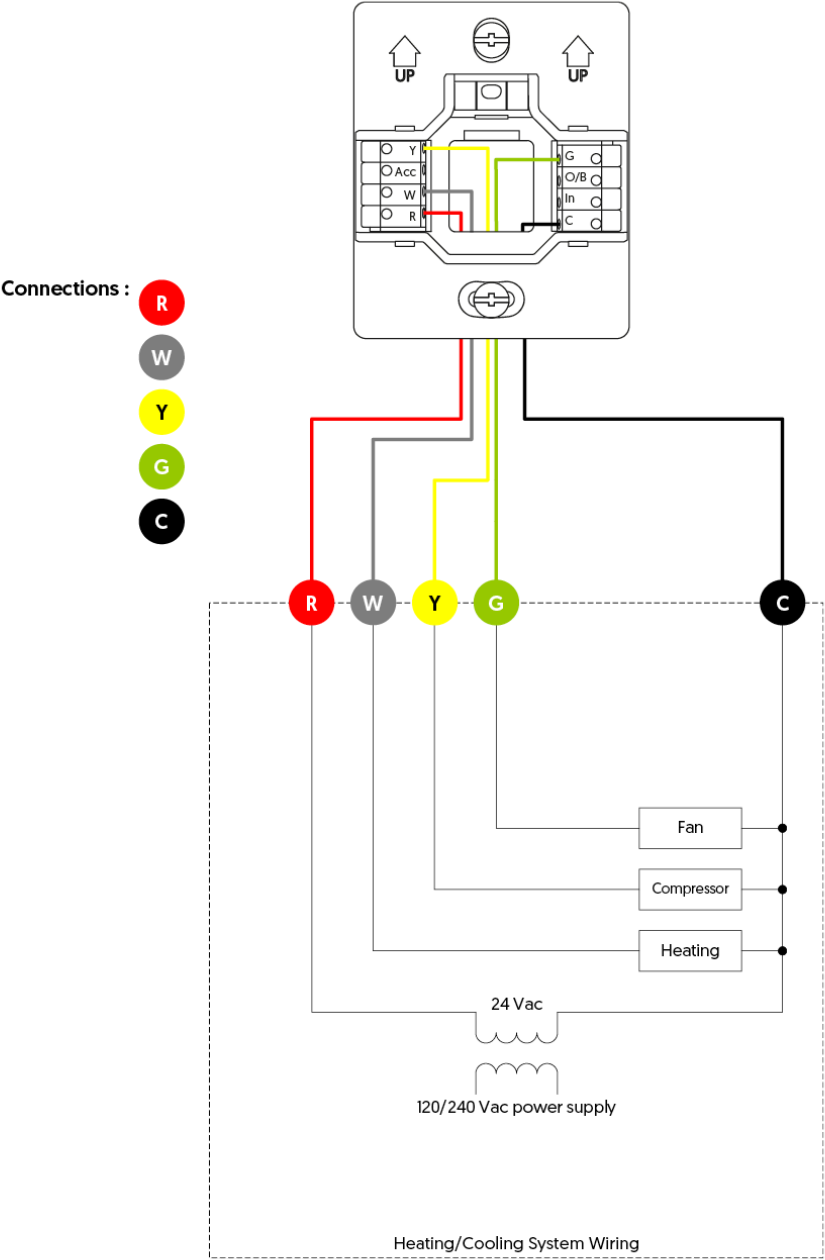

Heat pump

Wiring 5: 1H1C

System to control heating and cooling functions, as well as fan operation, at a single stage. Standard connection for heat pumps.

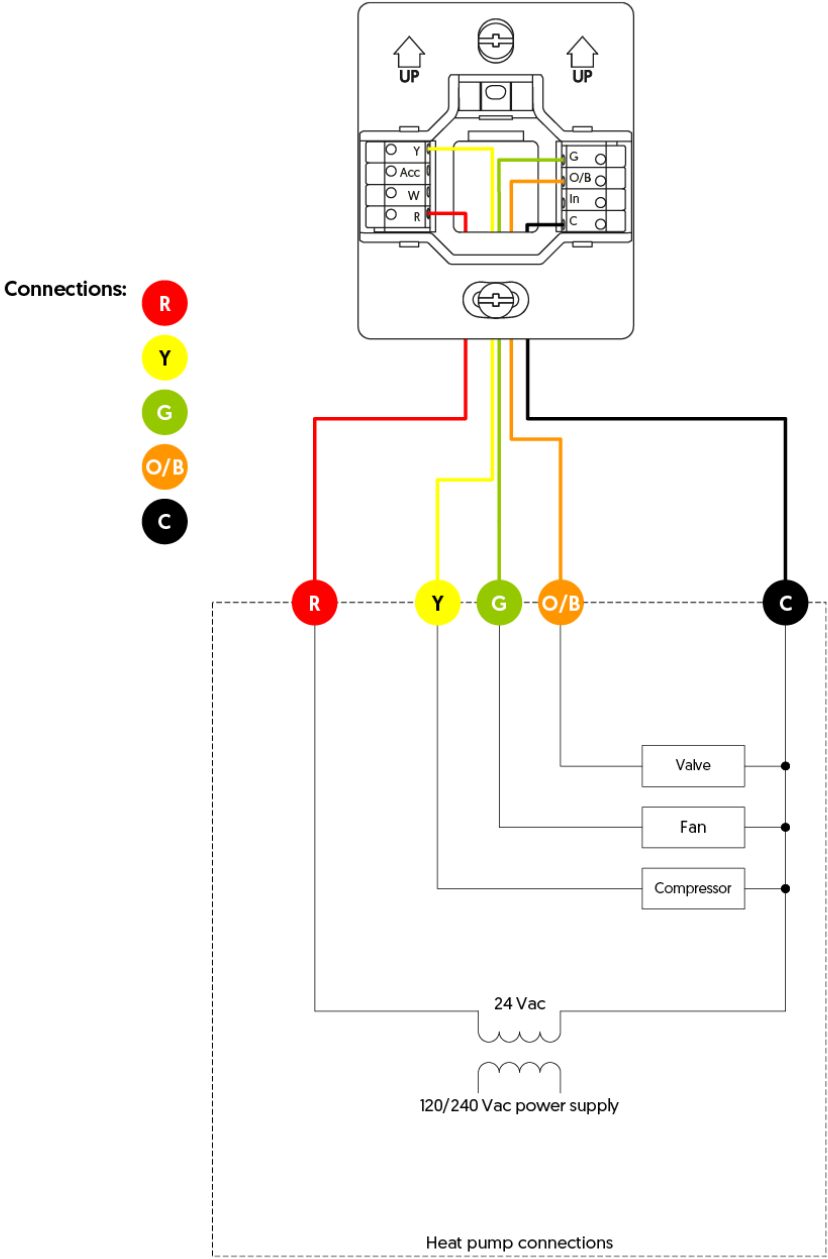

Wiring 6: 2H1C

Refers to an HVAC system with two heating stages and one air conditioning stage with ventilation control. Standard connection for heat pumps.

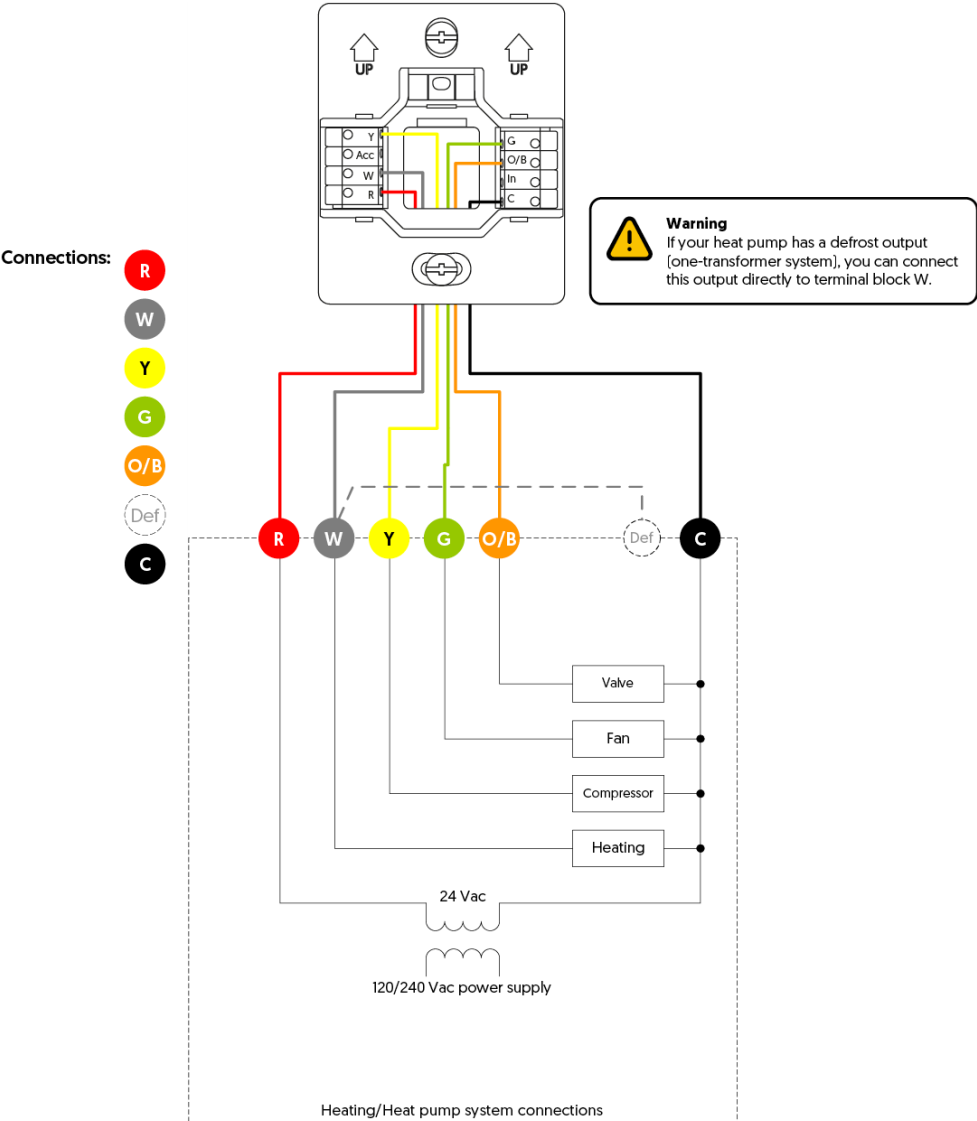

Additional system

Humidifier / Dehumidifier / Air exchanger

Wiring 7: Humidifier, dehumidifier, or air exchanger powered by the HVAC system.

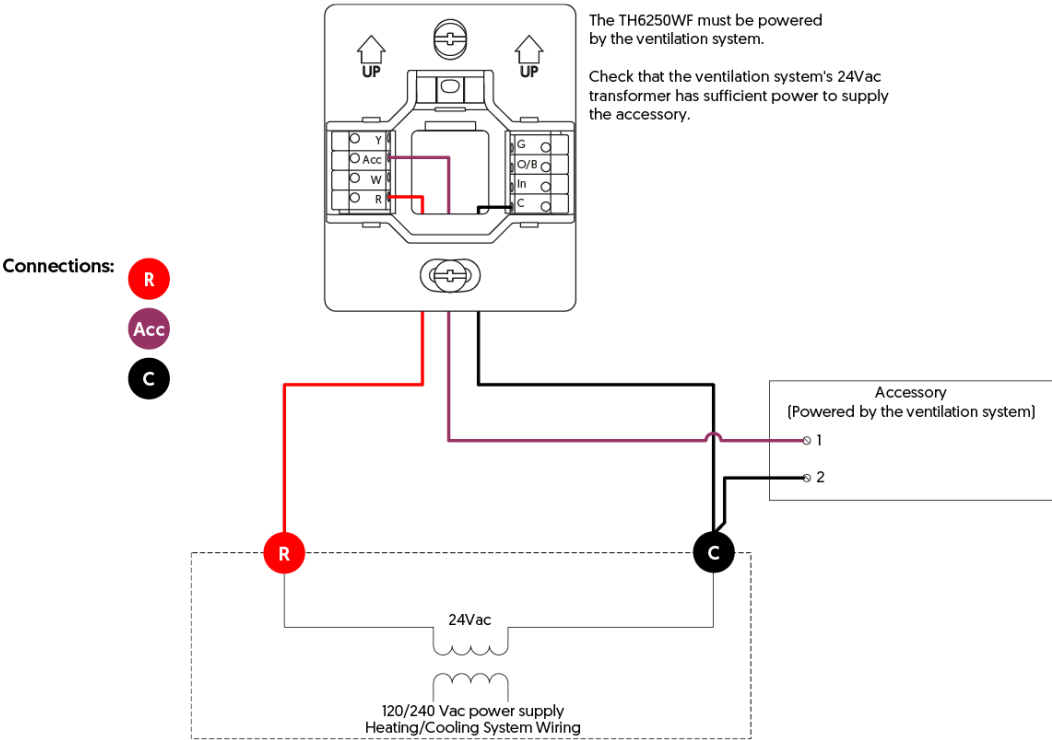

Wiring 7.2: Humidifier, dehumidifier, or air exchanger with an independent external power supply

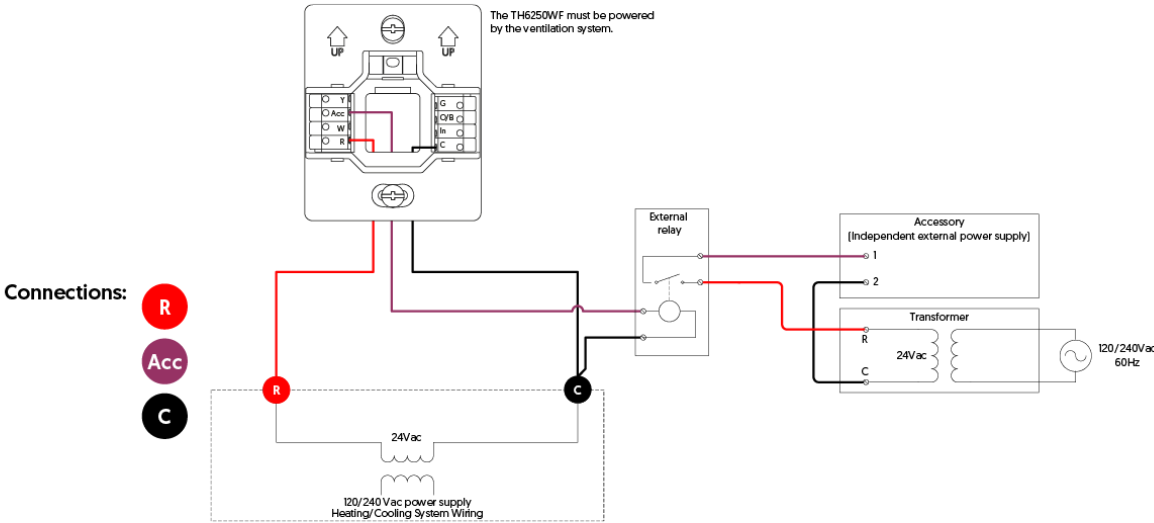

Wiring 7.3: Humidifier, dehumidifier, or air exchanger with an independent internal power supply

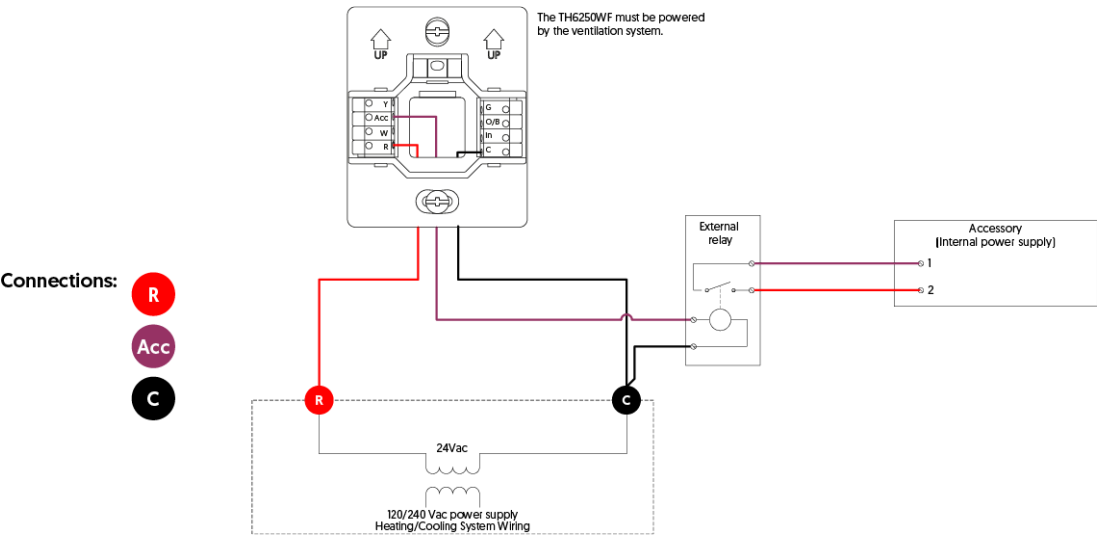

Wiring 8: Dual-energy

Connection for dual-energy signal.

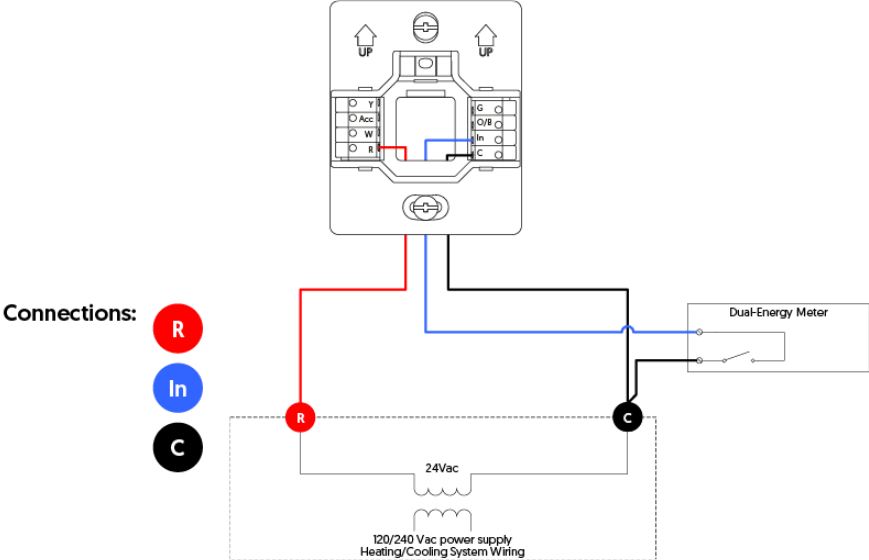

Wiring 9: SSR

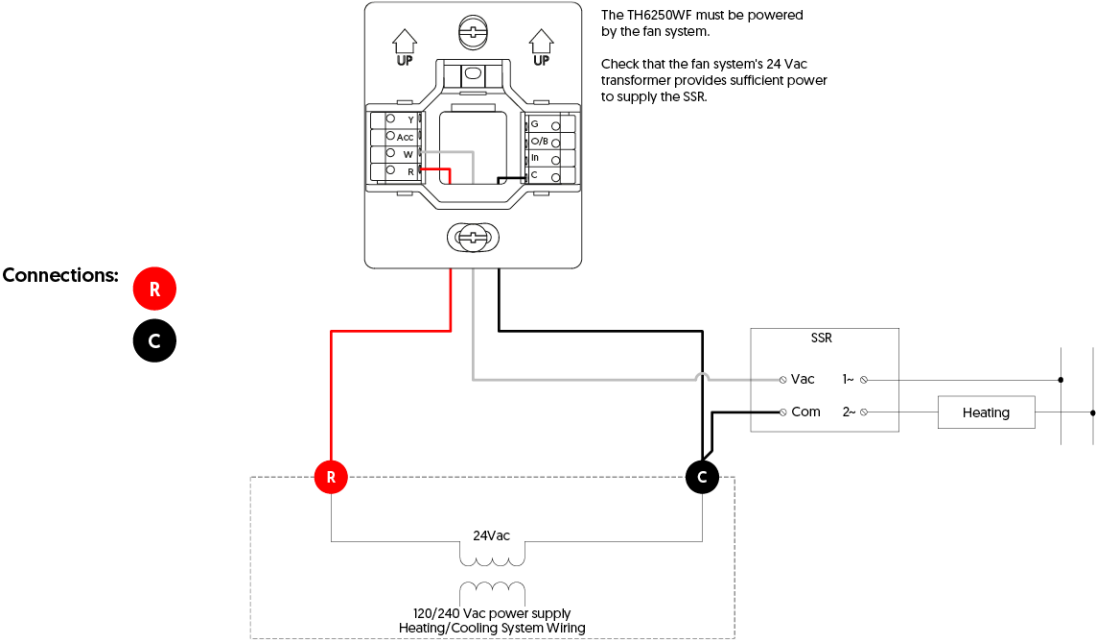

Additional accessories

Decorative mounting plates

Designed to cover wall imperfections left by the previous thermostat, they also include a steel plate for installing the thermostat above an electrical box.

When a junction box is used, the decorative plate **must** be installed to ensure **proper and secure** coverage of the junction box.



AC6500-01 Decorative Mounting Plate (sold separately)

Dimensions (W x H x D): 180.5 mm (7.11 in) x 112.5 mm (4.43 in) x 5 mm (0.20 in)

Included in the box:

- Decorative mounting plate
- Steel plate, installation sheet
- 2x screws for the decorative plate
- 2x screws for the steel plate

Installation diagrams for the AC6500-01 decorative mounting plate

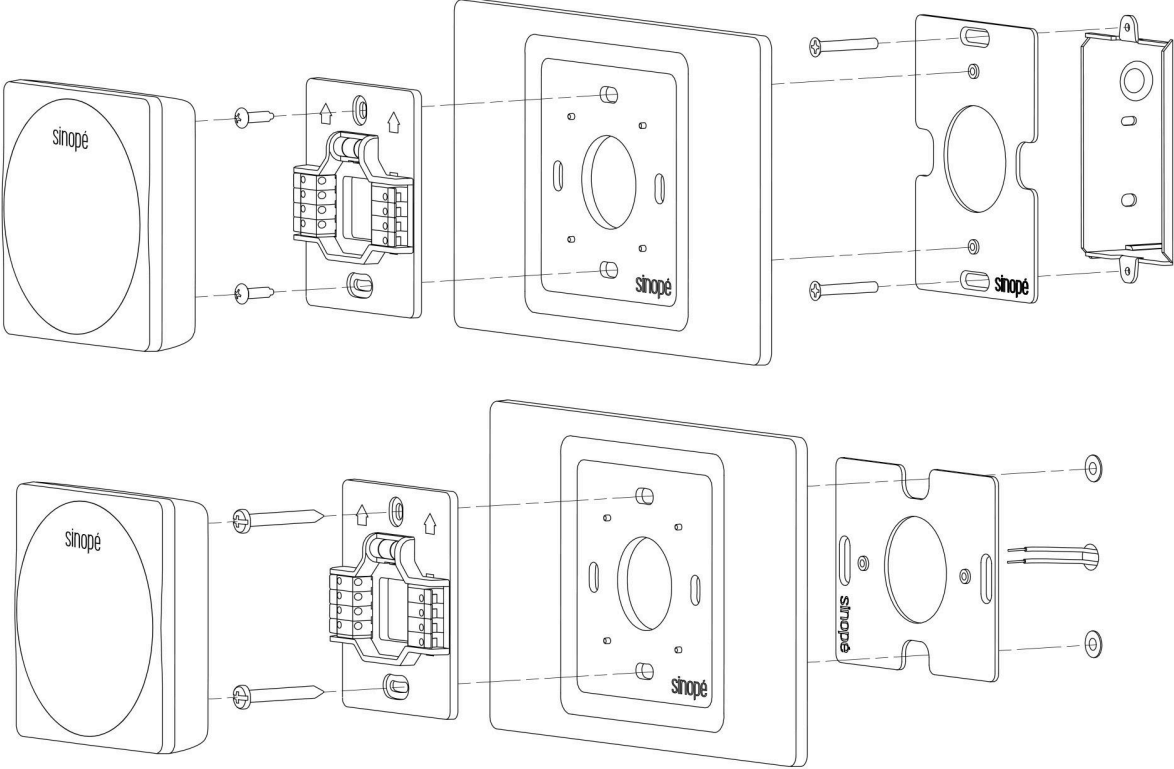



AC6500-02 Decorative Mounting Plate (included)

Dimensions (W x H x D): 114.3 mm (4.5 in) x 114.3 mm (4.5 in) x 4.8 mm (0.19 in)

Included in the box:

- Decorative mounting plate
- Steel plate, installation sheet
- 2x screws for the decorative plate
- 2x screws for the steel plate

Installation diagrams for the AC6500-02 decorative mounting plate

